

1.10mm Height 0805 Package
Bi-Color (Multi-Color) Chip LED
Technical Data Sheet

Part No.: DL-PCB0805SRPGC

Double Light

◆ Features:

1. Package in 8mm tape on 7" diameter reel.
2. Compatible with automatic placement equipment.
3. Compatible with infrared and vapor phase reflow solder process.
4. 2.00mm×1.80mm SMT LED, 1.10mm thickness.
5. Low power consumption.
6. Color: Hyper Red & Pure Green.
7. Bi-color type.
8. The product itself will remain within RoHS compliant Version.

◆ Descriptions:

1. The PCB 0805 SMD Taping is much smaller than lead frame type components, thus enable smaller higher packing density, reduced storage space and finally smaller equipment to be obtained.
2. Besides, light Weight makes them ideal for miniature applications, etc.

◆ Applications:

1. Automotive: Backlighting in dashboard and switch.
2. Telecommunication: Indicator and backlighting in telephone and fax.
3. Flat backlight for LCD, switch and symbol.

Double Light

◆ Package Dimension:

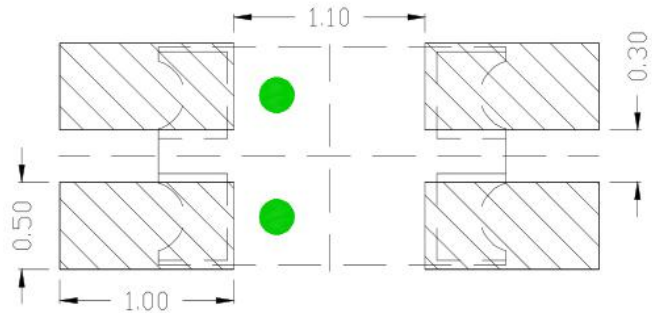
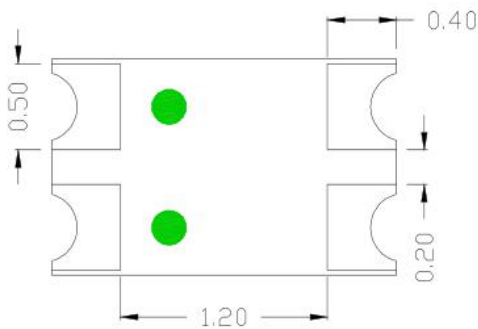
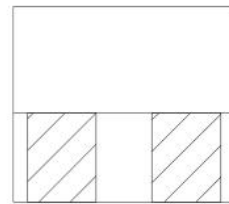
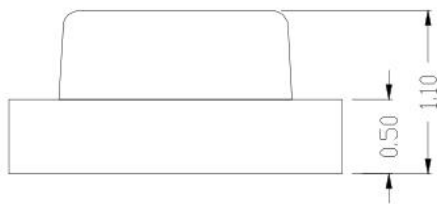
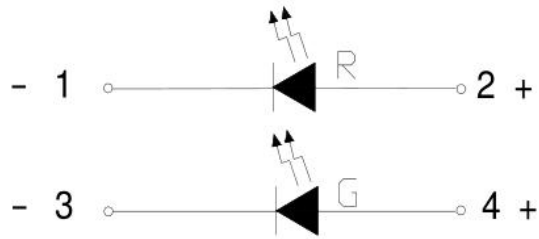
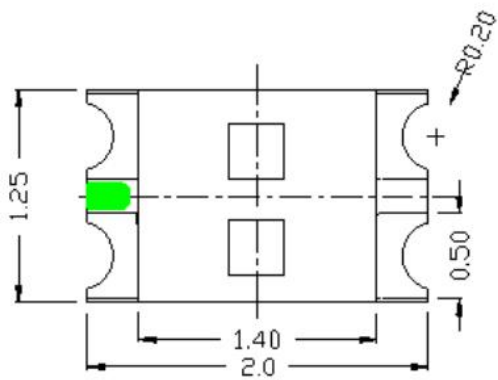

Part No	Chip Material	Lens Color	Source Color
DL-PCB0805SRPGC	SR	Water Clear	Hyper Red
	PG		Pure Green

Notes:

1. All dimensions are in millimeters.
2. Tolerance is $\pm 0.10\text{mm}$ (.004") unless otherwise noted.
3. Specifications are subject to change without notice.

Double Light

◆ Absolute Maximum Ratings at Ta=25°C

Parameters		Symbol	Max.	Unit
Power Dissipation	Hyper Red	PD	60	mW
	Pure Green		95	
Peak Forward Current (1/10 Duty Cycle, 0.1ms Pulse Width)		IFP	100	mA
Continuous Forward Current		IF	25	mA
Reverse Voltage		VR	5	V
Operating Temperature Range		Topr	-40°C to +80°C	
Storage Temperature Range		Tstg	-40°C to +85°C	
Soldering Temperature		Tsld	260°C for 5 Seconds	

Double Light

◆ Electrical Optical Characteristics at Ta=25°C

Parameters	Symbol	Emitting Color	Min.	Typ.	Max.	Unit	Test Condition
Luminous Intensity	IV	Hyper Red	100	170	---	mcd	IF=20mA (Note 1)
		Pure Green	200	320	---		
Viewing Angle	2θ _{1/2}	Hyper Red	---	130	---	Deg	IF=20mA (Note 2)
		Pure Green					
Peak Emission Wavelength	λ _p	Hyper Red	---	632	---	nm	Measurement @Peak
		Pure Green	---	520	---		
Dominant Wavelength	λ _d	Hyper Red	---	624	---	nm	IF=20mA (Note 3)
		Pure Green	---	525	---		
Spectral Line Half-Width	Δλ	Hyper Red	--	20	---	nm	IF=20mA
		Pure Green	---	35	---		
Forward Voltage	VF	Hyper Red	1.60	2.00	2.40	V	IF=20mA
		Pure Green	2.80	3.40	3.80		
Reverse Current	IR	Hyper Red	---	---	10	μA	V _R =5V
		Pure Green					

Notes:

1. Luminous intensity is measured with a light sensor and filter combination that approximates the CIE eye-response curve.
2. θ_{1/2} is the off-axis angle at which the luminous intensity is half the axial luminous intensity.
3. The dominant wavelength (λ_d) is derived from the CIE chromaticity diagram and represents the single wavelength which defines the color of the device.

Double Light

◆ Typical Electrical / Optical Characteristics Curves

(25°C Ambient Temperature Unless Otherwise Noted)

Hyper Red:

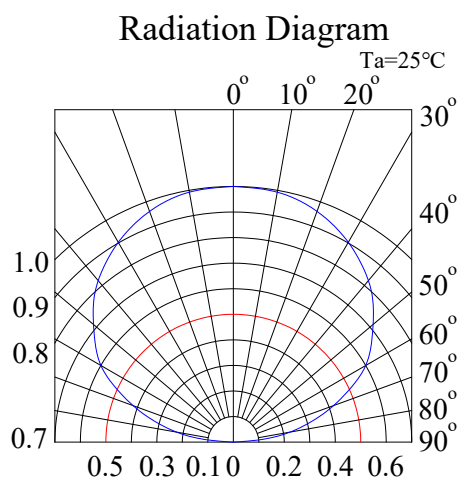
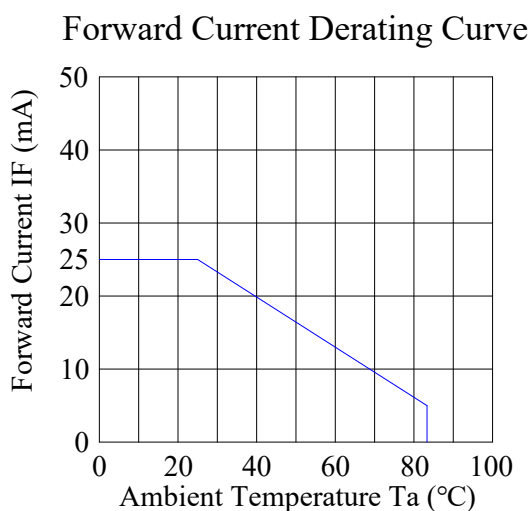
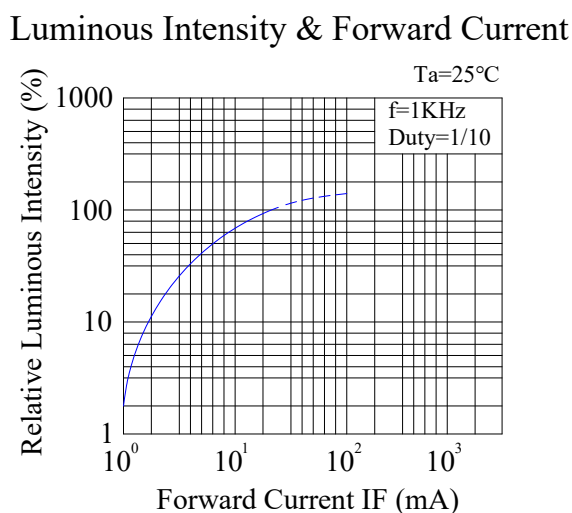
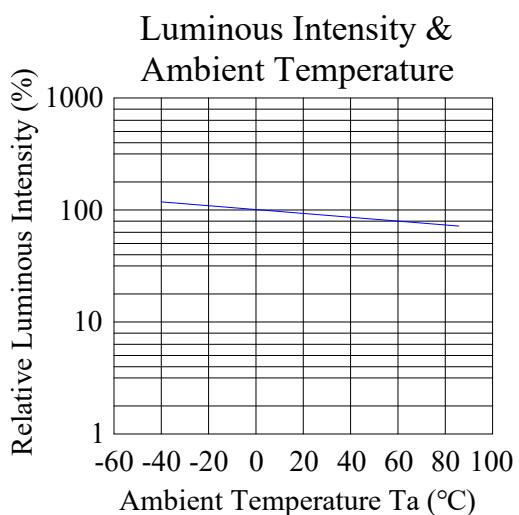
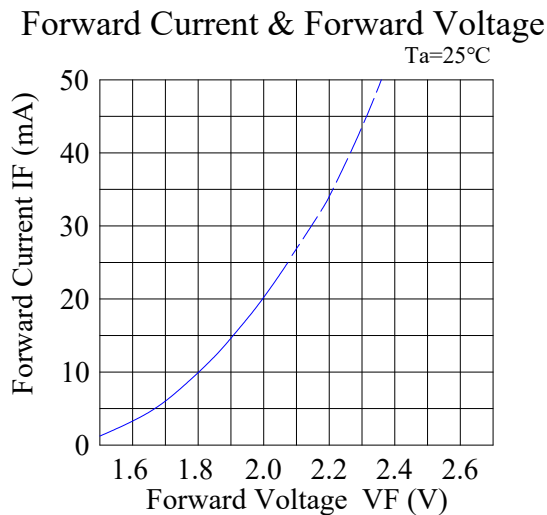
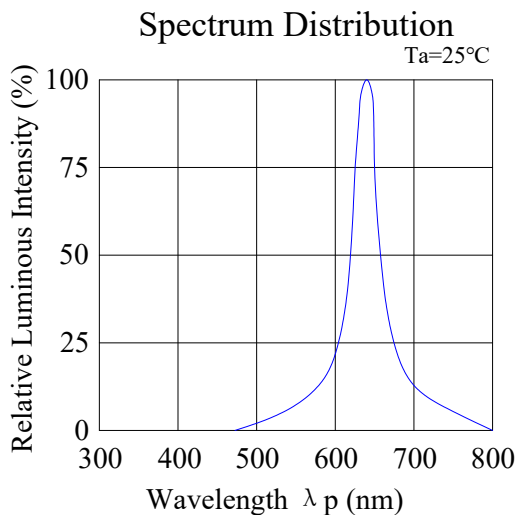

Double Light

Pure Green:

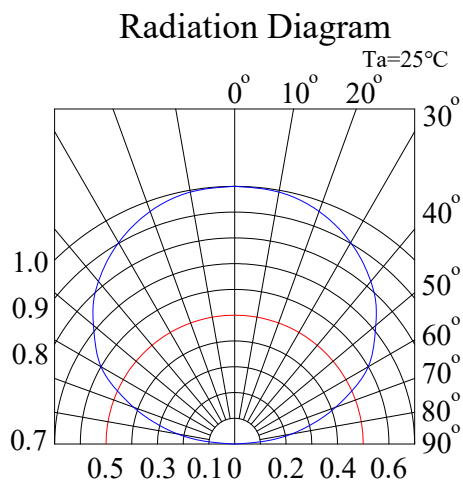
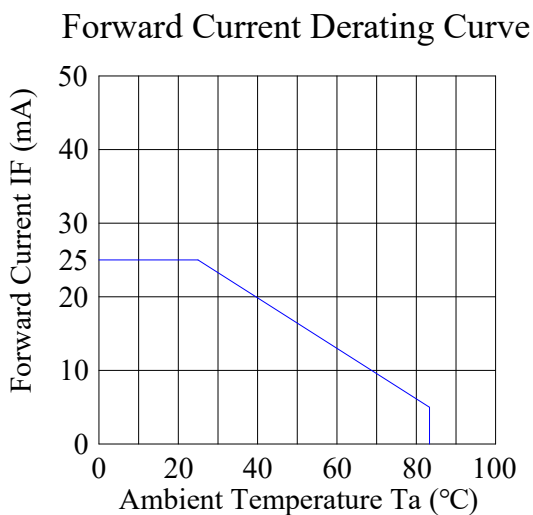
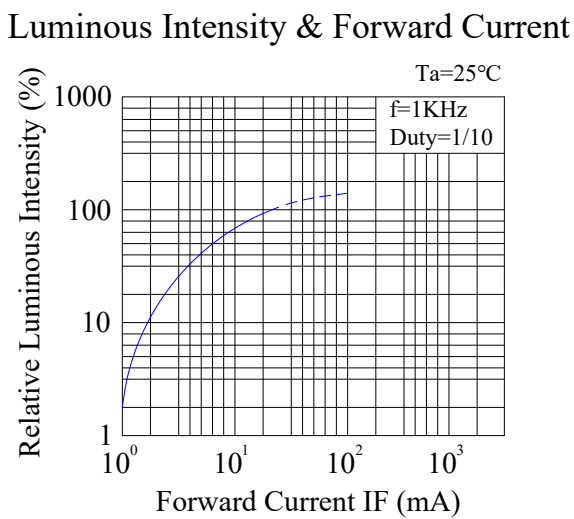
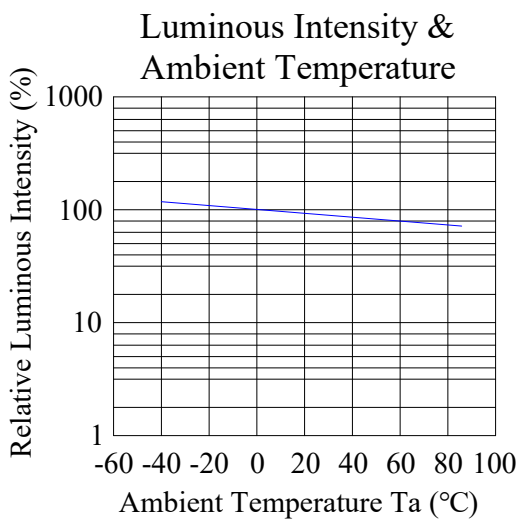
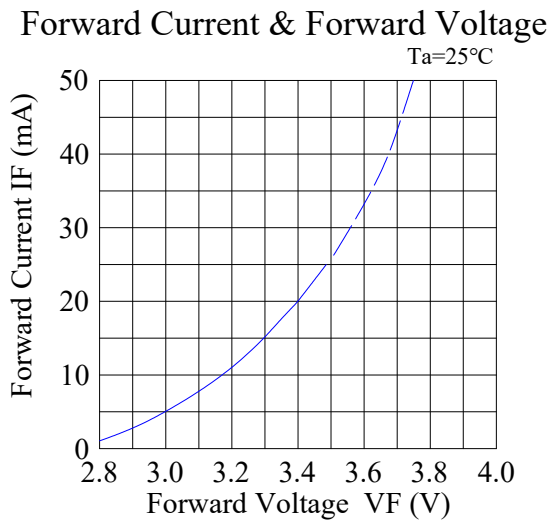
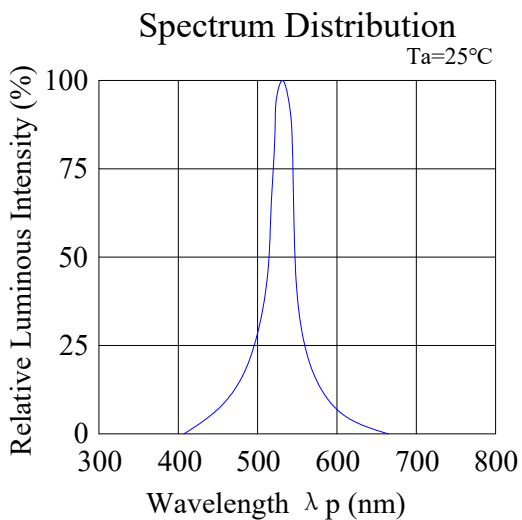

Double Light

◆ Reliability Test Items And Conditions:

The reliability of products shall be satisfied with items listed below:

Confidence level: 90%.

LTPD: 10%.

1) Test Items and Results:

No.	Test Item	Test Hours/Cycles	Test Conditions	Sample Size	Ac/Re
1	Resistance to Soldering Heat	6 Min	Tsld=260±5℃, Min. 5sec	25pcs	0/1
2	Thermal Shock	300 Cycles	H: +100℃ 5min f 10 sec L: -10℃ 5min	25pcs	0/1
3	Temperature Cycle	300 Cycles	H: +100℃ 15min f 5min L: -40℃ 15min	25pcs	0/1
4	High Temperature Storage	1000Hrs.	Temp: 100℃	25pcs	0/1
5	DC Operating Life	1000Hrs.	IF=20mA	25pcs	0/1
6	Low Temperature Storage	1000Hrs.	Temp: -40℃	25pcs	0/1
7	High Temperature/ High Humidity	1000Hrs.	85℃/85%RH	25pcs	0/1

2) Criteria for Judging the Damage:

Item	Symbol	Test Conditions	Criteria for Judgment	
			Min	Max
Forward Voltage	VF	IF=20mA	---	F.V.*)×1.1
Reverse Current	IR	VR=5V	---	F.V.*)×2.0
Luminous Intensity	IV	IF=20mA	F.V.*)×0.7	---

*) F.V.: First Value.

Double Light

◆ Reel Dimensions:

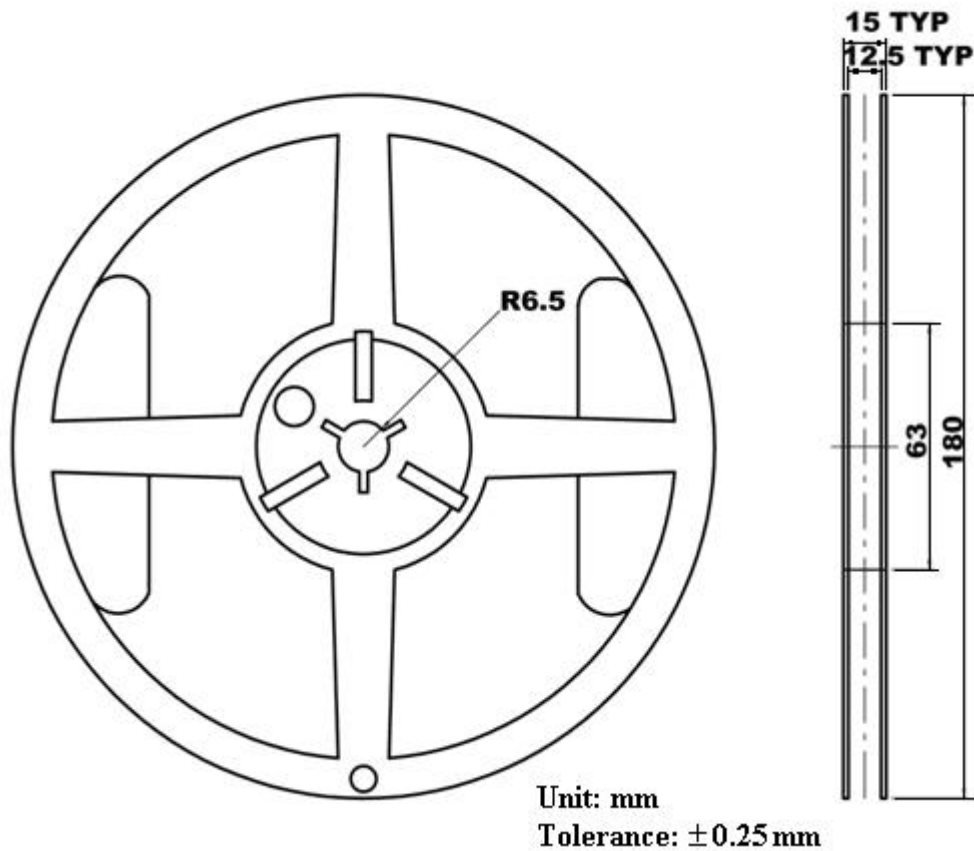

Carrier Tape Dimensions:

Loaded quantity 3000PCS per reel.

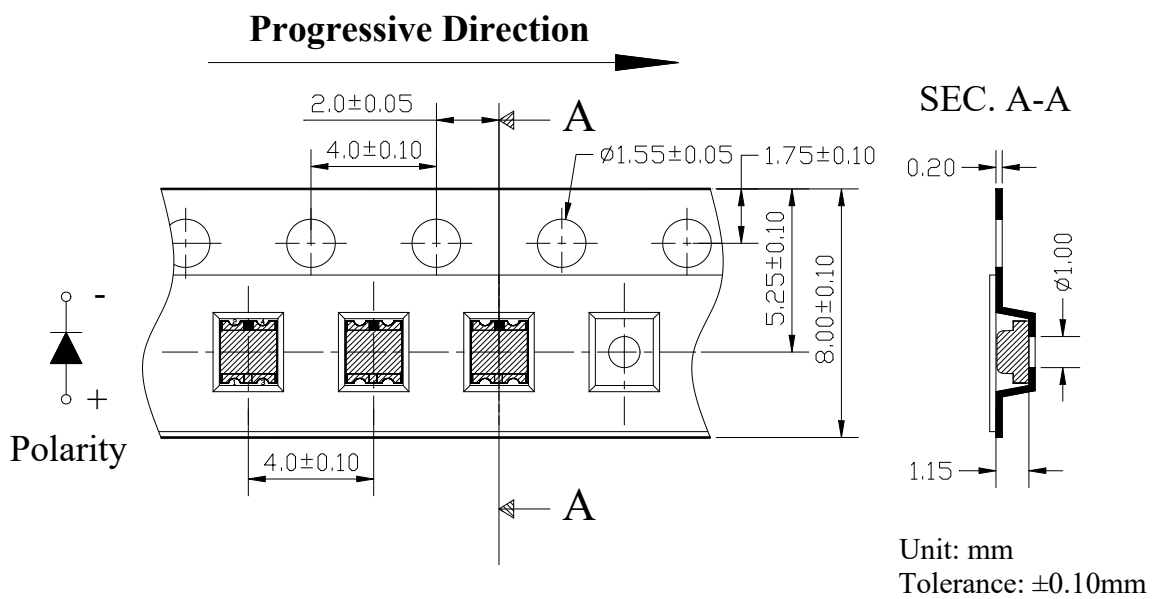

Double Light

◆ Please read the following notes before using the datasheets:

1. Over-current-proof

Customer must apply resistors for protection, otherwise slight voltage shift will cause big current change (Burn out will happen).

2. Storage

2.1 Do not open moisture proof bag before the products are ready to use.

2.2 Before opening the package, the LEDs should be kept at 30°C or less and 90%RH or less.

2.3 The LEDs should be used within a year.

2.4 After opening the package, the LEDs should be kept at 30°C or less and 70%RH or less.

2.5 The LEDs should be used within 168 hours (7 days) after opening the package.

2.6 If the moisture adsorbent material (silica gel) has faded away or the LEDs have exceeded the storage time, baking treatment should be performed using the following conditions. Baking treatment: 60±5°C for 24 hours.

3. Soldering Condition

3.1 Pb-free solder temperature profile.

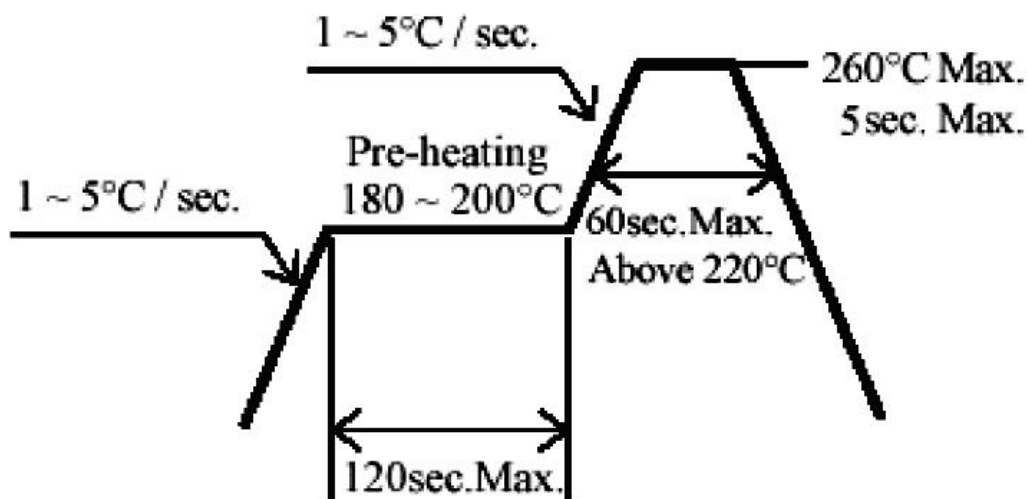

3.2 Reflow soldering should not be done more than two times.

3.3 When soldering, do not put stress on the LEDs during heating.

3.4 After soldering, do not warp the circuit board.

4. Soldering Iron

Each terminal is to go to the tip of soldering iron temperature less than 260°C for 5 seconds within once in less than the soldering iron capacity 25W. Leave two seconds and more intervals, and do soldering of each terminal. Be careful because the damage of the product is often started at the time of the hand solder.

Double Light

5. Repairing

Repair should not be done after the LEDs have been soldered. When repairing is unavoidable, a double-head soldering iron should be used (as below figure). It should be confirmed beforehand whether the characteristics of the LEDs will or will not be damaged by repairing.

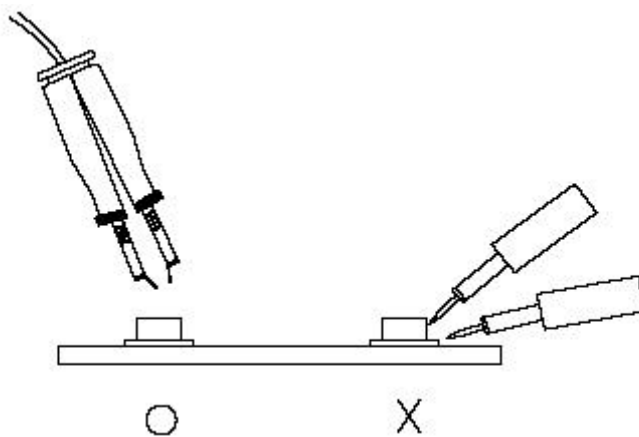

6. Caution in ESD

Static Electricity and surge damages the LED. It is recommended to use a wrist band or anti-electrostatic glove when handling the LED. All devices, equipment and machinery must be properly grounded.